



■ Vers. 064



■ Vers. 009



■ Vers. 003



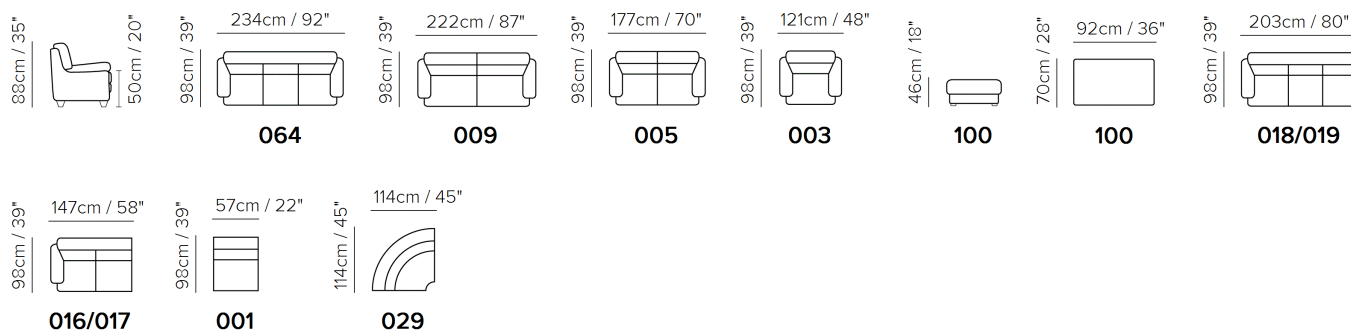

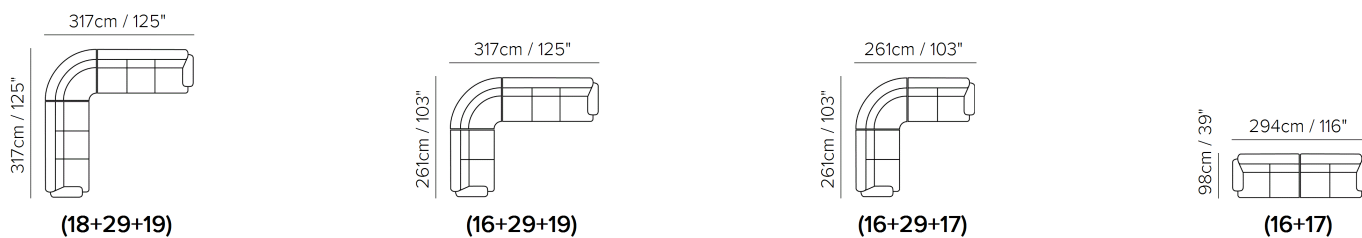

## SCHEMATICS



## COMPOSITION EXAMPLES



TECHNICAL INFORMATION

	<b>COVERING</b>	Leather <input checked="" type="checkbox"/>	Soft Cover <input checked="" type="checkbox"/>			
	<b>LEGS</b>	Wood <input checked="" type="checkbox"/>	Metal <input type="checkbox"/>	Plastic <input type="checkbox"/>	Castors <input type="checkbox"/>	Upholstered <input type="checkbox"/>
	<b>FILLING</b>	Arms <input type="checkbox"/> Fiber <input checked="" type="checkbox"/> Foam <input type="checkbox"/> Feather/Fiber Mix <input type="checkbox"/> Feather	Seat cushion <input type="checkbox"/> Fiber <input checked="" type="checkbox"/> Foam <input type="checkbox"/> Feather/Fiber Mix <input type="checkbox"/> Feather	Back cushion <input type="checkbox"/> Fiber <input checked="" type="checkbox"/> Foam <input type="checkbox"/> Feather/Fiber Mix <input type="checkbox"/> Feather		
	<b>COMFORT</b>	Standard Comfort <input checked="" type="checkbox"/>	Firm Comfort <input type="checkbox"/>			
	<b>FUNCTION</b>	Bed <input type="checkbox"/>	Electric motion <input type="checkbox"/>	Motion <input type="checkbox"/>	Recliner <input type="checkbox"/>	Sliding <input type="checkbox"/>
	<b>OPTIONS</b>	Removable <input type="checkbox"/>	Nails <input type="checkbox"/>	Contrast Stitching <input type="checkbox"/>		

NOTES

- Model is available with contrast welt (or any another decorative detail such as a band under arm cushion) to be entered as second covering in the same category.
- FABRIC: In fabric contrast welt (or any another decorative detail such as a band under arm cushion) can be made either in same category fabric or in leather with any color of Le Mans (only).
- Tight Seat Cushion (the seat cushions of the models are fixed to the frame)
- Loose Back Cushion (the back cushions of the model are not fixed to the frame)
- Wood Frame
- Without Feet Assembled (the feet will be in a bag inside the package)
- Plastic Wrap (the model will be wrapped in a plastic bag)
- Wooden base and legs available in finishing 09 (Walnut) / 18 (Wengè)
- Feet height 15,0 cm

NOTES

---